

Progettato da Arch. Bruno Colantonio
 Approvato da
 SEDE REGIONALE FRIULI-VENEZIA GIULIA
 Via C. Battisti, 10/D - 34125 TRIESTE
 COORDINAMENTO ATTIVITA' TECNICO EDILIZIA

TAV. 00
 Data GIUGNO 2015
 Scala 1:100
 UDINE - Piazza XX Settembre, 19
 ABACO INFISSI - P. Terra, 1°, 2°, 3°+ vano scala

mq. 13,70

Porta automatica

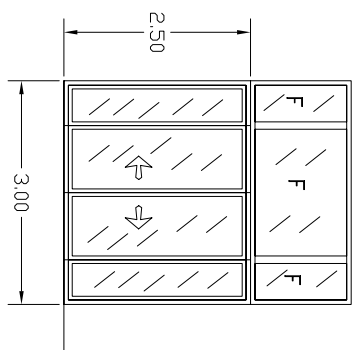

mq. 9,92

Vetrina P.Terra

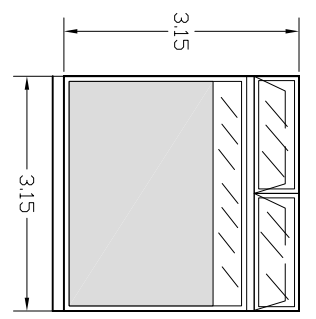

mq. 13,70

Vetrina P.Terra

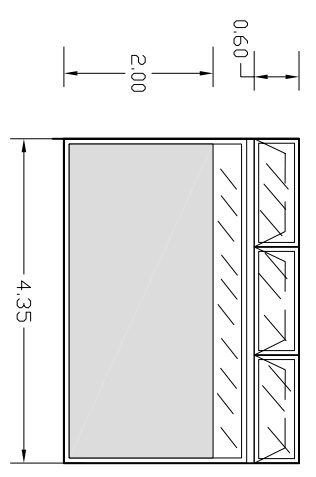

mq. 6,00

solo vetri

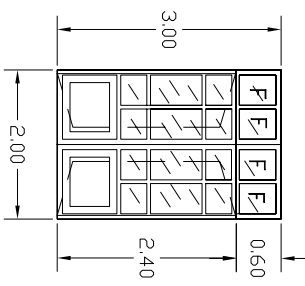

Cieca

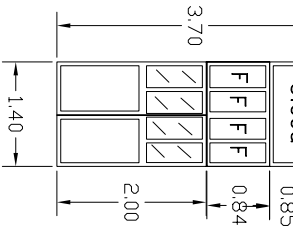

mq. 2,15

Porta nuove WC cieca

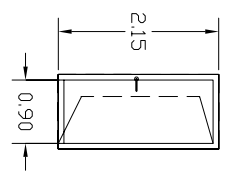
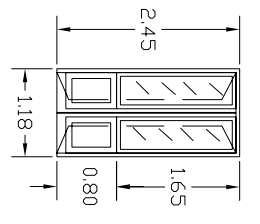

P. TERRA

Tipo P10
n. 1

Tipo Vetr.1
n. 1

Tipo Vetr.2
n. 2

Porta P7
n. 1
fronte ascen.

Porta P8
n. 1
lato ascens.

Porta P9
n. 1
guardiola

Tipo P6
n. 3

mq. 3,38

Infisso 3 ante

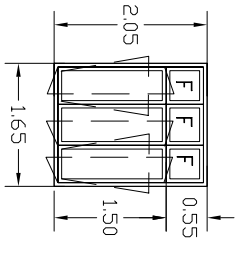

mq. 2,50

Infisso 2 ante

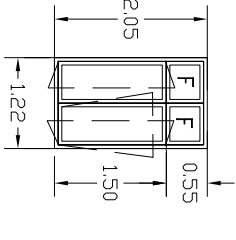

mq. 2,25

solo vetri

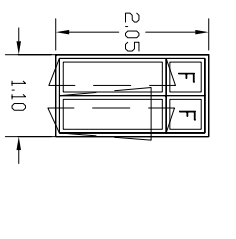

mq. 1,15

Infisso 1 ante

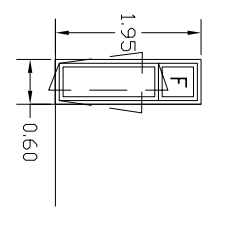

mq. 45,56

sulla scala

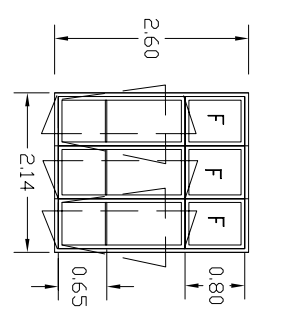

mq. 4,00

solo vetri

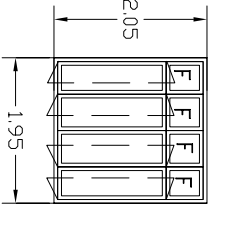

mq. 3,54

Balcone 1 ante

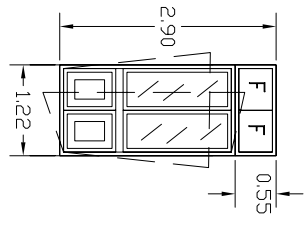

mq. 3,54

Balcone 1 ante

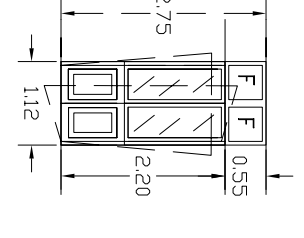

mq. 4,48

2° Piano

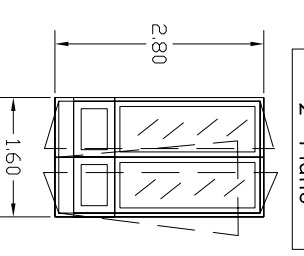

1° Piano

Tipo F1
n. 2

Tipo F2
n. 16

Tipo F3
n. 6

Tipo F4
n. 2

Tipo F5
n. 5

Tipo F6
n. 1

Tipo F7
n. 1

2° Piano

Tipo F2
n. 10

Tipo F3
n. 5

Tipo F4
n. 2

Tipo F5
n. 5

Tipo F6
n. 1

Tipo F7
n. 1

Tipo F8
n. 3

balcone
n. 2

3° Piano

Tipo F2
n. 1

Tipo F3
n. 1

Tipo F5
n. 1

Tipo F6
n. 1

Tipo F7
n. 1

Tipo F8
n. 1

mq. 2,93

Porta interna 2 ante con vetri

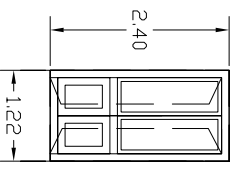

mq. 2,38

Porta interna 1 anta cieca

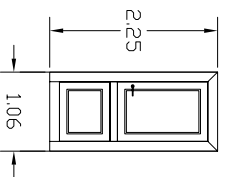

mq. 2,38

Porta interna 1 anta vetrata

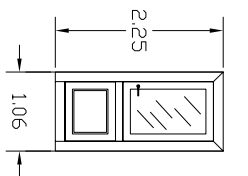

mq. 4,85

1° Piano

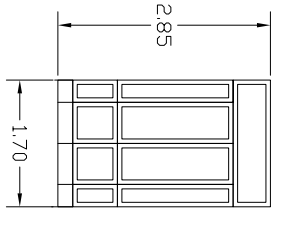

mq. 2,15

Porta interna cieca liscia

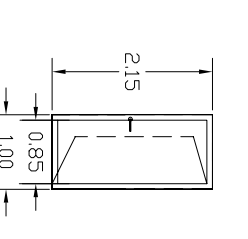

mq. 2,15

Porta nuove WC cieca

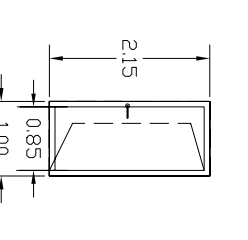

mq. 3,38

Scuro esterno

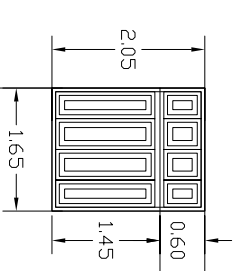

mq. 2,50

Scuro esterno

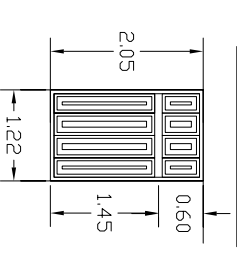

mq. 2,25

Scuro esterno

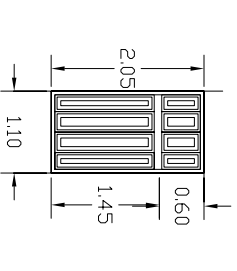

1° Piano

Tipo P1
n. 14

Tipo P2
n. 4

Tipo P3
n. 3

Tipo P4
n. 2

Tipo P5
n. 4

Tipo P6
n. 2

per Tipo F1
n. 2

per Tipo F2
n. 16

per Tipo F3
n. 6

2° Piano

Tipo P1
n. 14

Tipo P2
n. 3

Tipo P6
n. 1

per Tipo F1
n. 1

per Tipo F2
n. 10

per Tipo F3
n. 5

3° Piano

Tipo P1
n. 1

Tipo P2
n. 1

Tipo P6
n. 1

per Tipo F1
n. 1

per Tipo F2
n. 1

per Tipo F3
n. 1