



Data di pubblicazione: 27/03/2018

Nome allegato: *Allegato C - PARTICOLARE - A - ZONA 2 - MI-NORD-Model.pdf*

CIG: Z3222EDEBB;

Nome procedura: *Invito a procedura negoziata ai sensi dell'art. 36, comma 2, lettera a), e comma 6, del D.Lgs. 50/2016, effettuata mediante il Mercato Elettronico della P.A., volta all'affidamento della "Fornitura di: n. 10 scrivanie operative front office, n. 10 cassettiere, n. 10 sedute per operatore con ruote, n. 23 sedute per ospite, n. 3 scrittoi per pubblico, n. 2 banconi reception e n. 5 paretine divisorie da installare nella Zona 1 e Zona 2 site al piano terra dell'Agenzia complessa INPS di Milano Nord, in via Silva 38, Milano (MI)"*

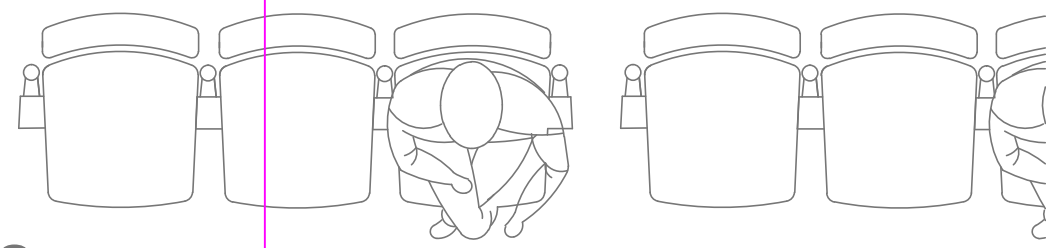
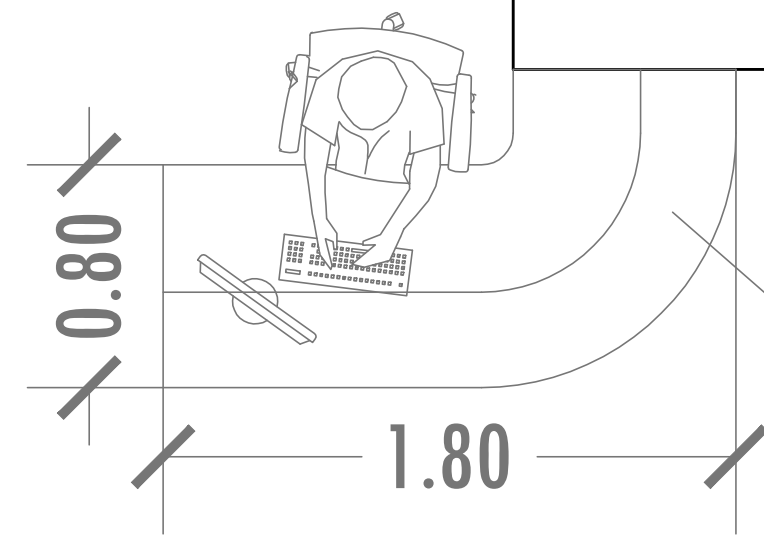
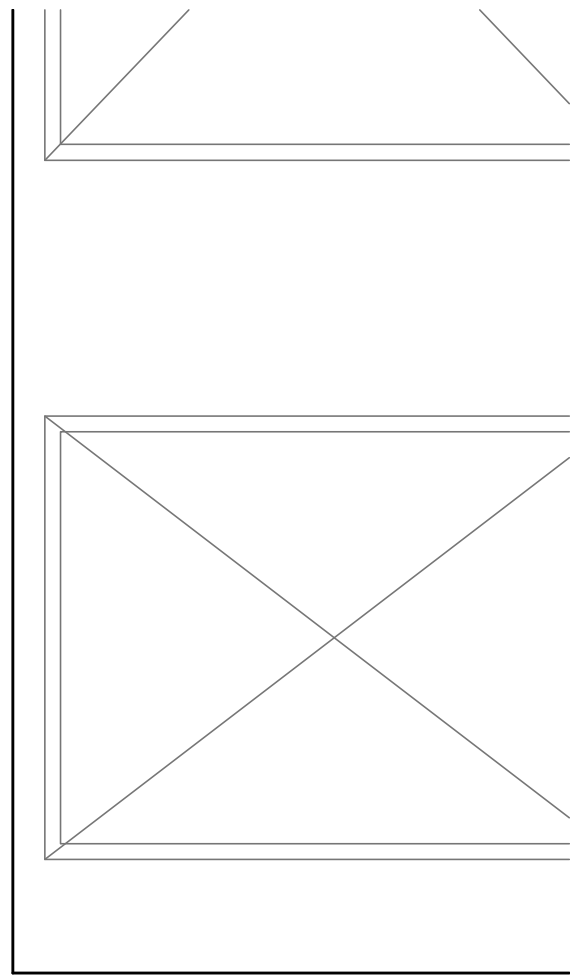
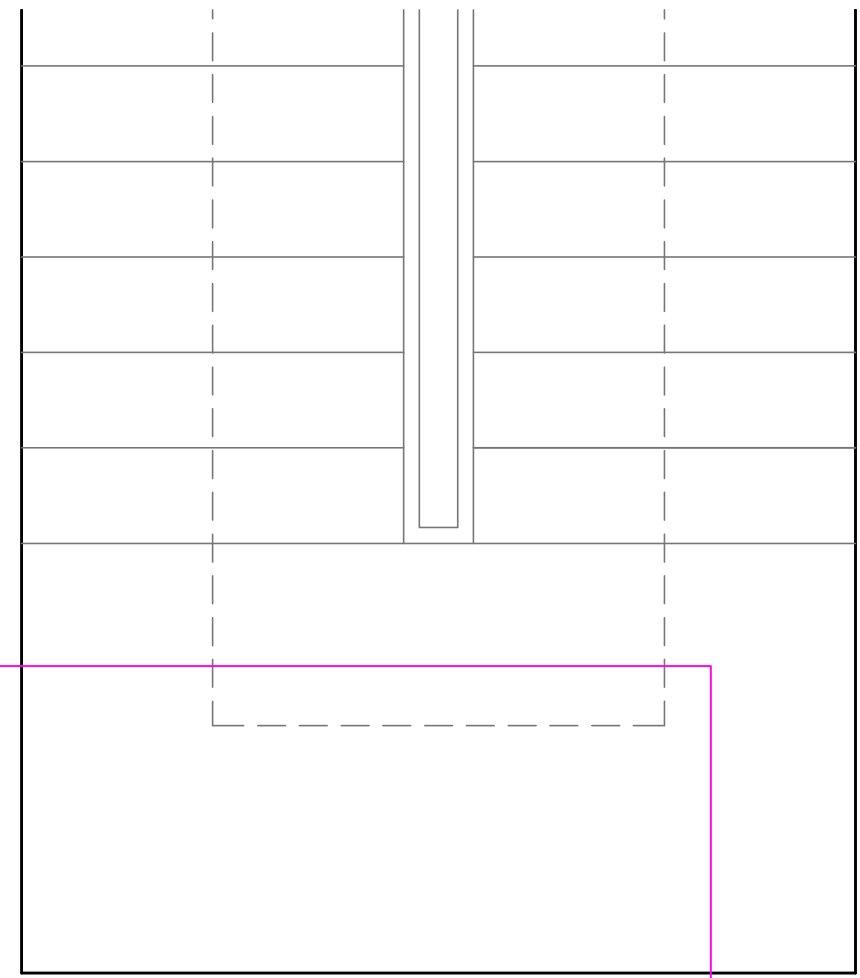
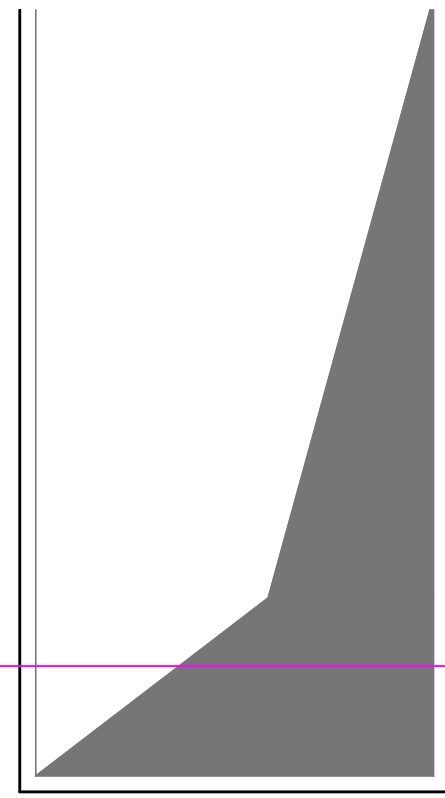
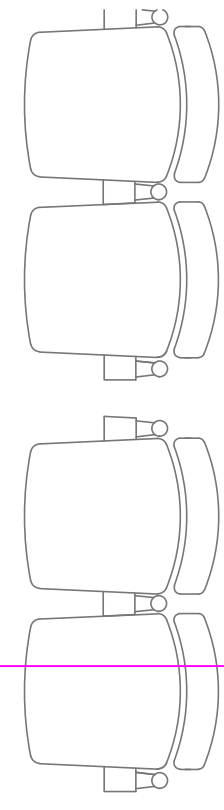
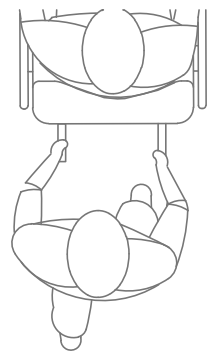
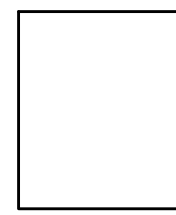

VETRO

GUARDIA GIURATA

A